

# TAIWAN HARDWARE

2024 Autumn

- 1.Handtools..... 19
- 2.Building.....43
  - Bathroom
- 3.Rubber..... 66
  - OEM/ODM



cnc working  
P13/P67



rubber  
P9/P73



belt  
P11/P77



handtools  
P20



Storage Suction  
P45/P46



handtools  
P15/P23



handtools  
P17/P25

1



**SHARP-EYED**  
Precision Parts CO., LTD.

# Fast Solution for Precision Parts





- Wearable device components
- Medical related components
- Precision CNC turning and milling composite parts
- Vertical milling machine manufacturing
- Various post process development
- Cycling components
- Fasteners/standoff
- Plastic insert nuts
- Watch bezels
- Buttons
- Pins



## 千里眼精密部件股份有限公司 Sharp-Eyed Precision Parts CO., LTD.

No. 8, Tianxin St., Daya Dist., Taichung City 42874, Taiwan 台中市大雅區田心街8號  
 Tel: 886-4-25658080 Fax: 886-4-25679458  
 Email: sales@sharpeye.com.tw <https://www.sharp-eyed.com>



**TLA**®  
**TELEANTOOL**  
 TELEANTOOL CO.,LTD.



Professional Electric Power Equipment Tool



PROFESSIONAL HAND  
 TOOL PRODUCTION

 [www.teleantool.com](http://www.teleantool.com)

 E-mail: [tla@teleantool.com](mailto:tla@teleantool.com)

 No.19-39, Ln.50, Xinxiang St., East Dist., Hsinchu City 300, Taiwan



# JOHNSON TOOLS CO., LTD.

PROFESSIONAL  
FORGING  
IMPACT TOOLS  
HAND TOOLS



No. 83, Lane 22, Sec. 1, Xinren Rd., Taiping Dist., Taichung City, 41143 Taiwan  
Tel:886-4-2279-8181 Fax:886-4-2277-0728  
E-mail:johnson.tools@msa.hinet.net  
URL:www.johnson-ytc.com

# Lntool®

LNTOOL INDUSTRIAL CO., LTD.

*Innovating for better tomorrow*

Professional Manufacturer  
OEM / ODM Selected Suppliers



No. 26, Lane 213, Fuya Rd., Xitun Dist., Taichung City 407, Taiwan

Tel: 886-4-2461-8959

Fax: 886-4-2461-9539

E-mail: [SERVICE@LNTOOL.COM.TW](mailto:SERVICE@LNTOOL.COM.TW)

URL: [www.lntool.com.tw](http://www.lntool.com.tw)



**FUIN**  
Design Hardware

# Crystal Door Knob



## **FU IN C.M. ENTERPRISE CORPORATION**

No.27, Ln.40, Sec.1 Zhongshan Rd.,  
Huatan Township, Changhua City, Taiwan  
TEL:+886-4-7872997  
FAX:+886-4-7871987  
E-mail:info@fuindh.com  
Http://www.fuindh.com



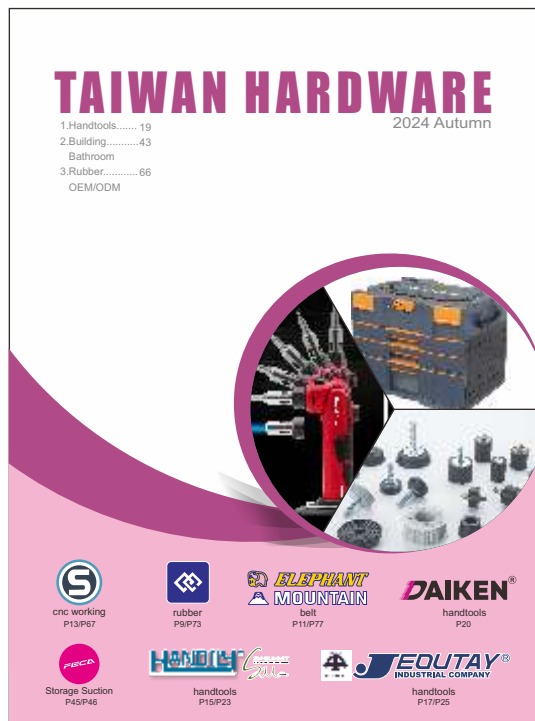

# H·miT

## TAIWAN HARDWARE SUPPLIERS DIRECTORY

Publisher: Darren Ho  
Editor: Darren Ho, Ivy Liu  
Design: Chia-hui Lee

### Office:

13F-5, No. 100, Sec. 1, Zhongqing Rd.,  
North Dist., Taichung City 404, Taiwan  
TEL: +886-4-22038853  
FAX: +886-4-22083823  
E-mail: info@hmit.com.tw  
Http://www.hmit.com.tw  
taiwan-hardware.tw

出版：形象廣告企劃社  
主編：何東楸

台中市北區中清路一段100號13樓之5  
電話：04-22038853  
傳真：04-22083823  
信箱：info@hmit.com.tw  
平台：www.hmit.com.tw  
taiwan-hardware.tw





## Storage Suction System

With the unique core technology of suction cups and creativity, FECA stylish suction hooks/ storage holders are tool-free, durable, 100% waterproof and reusable that assist your daily organization to become easy and convenient. There is no damage to the wall and its reusable feature are environment-friendly. ..

FECA is not just the great houseware, but also the way to show your smart taste because it creates the new lifestyle with the combination of functions and elegance. Its simple but beautiful design also becomes an essential fashion trend in the world. There are many FECA products winning the Taiwan Excellence Award. FECA create the smart storage life with you wherever whenever.





### Environmental SVHC Control

A rubber product is a highly elastic object formed by a multi-component combination of substances through a certain cross-linking reaction. It is generally composed of raw rubber, fillers, plasticizers, active agents, accelerators, vulcanizing agents, and other additives (pigments, odors, electrical conductivity, etc.).....

There are many types of rubber, and natural rubber (raw gum) itself is non-toxic. The toxicity of some industrial rubber products comes from chemical additives and has nothing to do with rubber. However, due to the use of many chemical additives in the rubber processing process, various toxic substances/gases/pollutants may be generated during the processing. Rubber products used for contacting/packaging/processing food are processed in strict accordance with SVHC by ECHA, and the final product can be considered non-toxic.

Therefore, the careful selection of additives is a profound problem CHIEN CHIE not only represents ISO certification, but also strict with suppliers supplying RoHS & REACH certificates for take care of earth.



Formulation Technology And Design



Design rubber tooling is a key of essential. The vulcanization processing of rubber productions will affect productions shape and physical characteristics. In addition, the rubber release agent used to improve the release of the molded product is also an important choice CHIEN CHIE rubber has an excellent team to solve all problems for you, product size difference, performance improvement, etc. We can provide you with suitable solutions to assist you!



E-mail: [tccr@chien-chie.com.tw](mailto:tccr@chien-chie.com.tw)



## Professional Transmission Belt

### Timing Belt



Timing belt drive can replace V-belt drive and chain drive. Over time, timing belts have evolved from trapezoidal to round teeth.

#### Torque Efficiency:

The meshing of the belt and pulley grooves keeps the timing belt free from heat loss. The thin cross-section of timing belts allows them to require very little energy to bend and attach to the pulleys.

#### Speed loss:

The perfect meshing of the timing belt teeth and the pulley grooves keeps the belt from slipping. When the timing belt is installed correctly, the belt does not need to be tensioned again due to the small elongation of the belt.

### Multi rib V-belt

The V-type drive belt is made of special rubber mixed with other materials, so it provides quite high stability, and has the characteristics of anti-electricity, anti-oil and high-temperature resistance. Widely used in many fields, especially in automation control systems. Models PH&PJ are usually used in sports equipment and industrial machines, and models PK are used in the automotive industry.



### Agriculture Belt

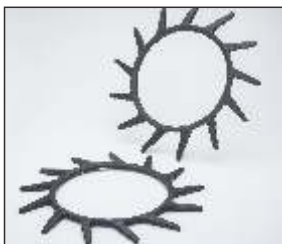

Agricultural belts are designed to perform high power transmission under extreme working conditions and have good stability to adapt to harsh working environments.

- Specially formulated rubber compound
- Excellent resistance to bending stress
- Excellent antistatic, oil resistance, heat resistance, waterproof and other properties
- Good stability, not easy to slip and jump during transmission





## Transmission V-Belt

V-belts are the most widely used and most types of all drive belt types, especially in Industrial drive and vehicle applications. The cross-section of the V-belt is trapezoidal, which can be tightly wedged into the sheave to increase the frictional force, transmit it by frictional force, and allow a large torque to be transmitted before the slip occurs. The friction force can be increased by using the V-belt, and the friction force required for transmission does not need to be maintained by a large tension like a flat belt, so the load of the sheave bearing can be reduced. In addition, the alignment is better. Does not require.

The transmission capacity (friction force) of the V-belt is determined by the angle and thickness of the two inclined surfaces. When the angle is smaller, the positive force on the friction surface is larger; In these two cases, the friction force is larger, that is, the transmission capacity is larger. However, when the angle is small, the difference between the width of the upper surface and the lower surface is small, and the cross-section is approximately square, so the belt is prone to overturning and curling during running; and when the thickness is larger, the bendability is smaller and cannot be used for For pulleys with small diameters, in general, the angle is about 40 degrees, and the ratio of the width to the thickness of the upper surface is about 1.6.



## OEM&ODM Rubber Products



E-mail: [tahs3566@tahs-belts.com](mailto:tahs3566@tahs-belts.com)



## Professional Metal Parts Manufacturer

Lathe processing / CNC lathe processing is an essential processing method for industrial components in recent years, and the quality of workpieces processed by lathes has become increasingly critical.

Ele Shine Metal Industrial Co., Ltd, is profoundly aware of this, using Japanese high-precision CNC lathes, inspection instruments to maintain the quality of workpieces, which is a star in the industry, and has been cooperating with many leading companies worldwide.

All kinds of materials can be processed, for instance, iron metal, copper metal, aluminum alloy, stainless steel etc. We consistently adhere to a creed "Make friends with quality".



Ele Shine Metal Industry Co., Ltd. was established in 1980 in Taiwan, is a professional computer CNC automatic lathe milling precision metal parts manufacturer. The main products used in computer components , bicycle parts , optoelectronic components , machine auto parts , gas parts, electronic parts, communication parts, bathroom hardware, machinery, hardware, pneumatic tools , sports equipment, buried screws and nuts , all kinds of connectors the high-precision parts manufacturing and processing . From high-speed lathes, automatic lathes, lathe tool path , and even take heart . CNC lathe and milling at once. Different products require visualization , and provide reliable solutions ! Machining brass , beryllium copper, phosphor bronze ,copper, stainless steel, free cutting steel, alloy steel , steel, aluminum , plastic and other materials , but also with the product as anodizing, polishing , vibration , magnetic resonance imaging , plating, Black , passivation , heat treatment, chromate , phosphate , coating and other surface treatment , processing capacity from OD 2 ~ 42 mm, length 600 mm of precision metal parts can be .

E-mail:ele.shine@msa.hinet.net

## ISO 9001:2015 International quality certification factory



Ele Shine Metal Industries CNC lathe deep plowing business for over twenty years, take heart automatic lathe, automatic lathe tool path, CNC automatic lathe milling complex visual products of different products require order items throughout the steam locomotive, bicycles, computers , electronic, optical, mechanical and electrical, precision mechanical, plumbing, appliances, machinery, hardware, pneumatic tools, sports equipment ... and other industries. Ele Shine Metal Industry's products have passed the ISO 9001:2015 international quality certification, and the introduction of ESPRIT CAM software applications specialized lathe design, integrate and simplify the process of production materials and processing, in order to ensure and enhance quality control system, Yixiang Metal Industry continue to buy high reliability testing instruments: such as projectors, high-resolution projectors, electronic height gauge, surface roughness tester and all kinds of microscopes and precision dental regulations and so on. Under the strict control from the material, tool applications, milling process, to the finished product, complete control, our professional quality control staff to focus on customer quality control of various precision parts to ensure the highest accuracy and quality



Our OEM Products covered by numerous industries, including bicycle parts, motorcycle parts, electronic parts, sanitary hardware parts, machinery parts, special screw cap, pneumatic parts. Processing of materials can be used with a wide range of customer needs: Contains copper, stainless steel, iron, plastic and aluminum. The O.D. range available is from  $\varnothing$  2 mm to  $\varnothing$  42mm and a maximum length of 600 mm





HANDILY INDUSTRIAL CO., LTD. was established in 2003. It is a manufacturer specializing in the manufacture of special auto repair tools. The products are suitable for the world's major brands of automobiles and are indispensable hand tools for automobile maintenance.

For example:

- Puller for Ribbed Drive Pully .
- Syringe Pump Removal Installation Tool .
- Engine Timing Kit .
- Engine Timing Tools .
- Camshaft Adjuster .
- Cummins Timing Tools .
- Fuel Injector Seal Remover Fitting Install Tool .
- Fuel Injector Removal / Installation Tool Kit .
- It has a place in the global supply of hand tools .



Puller For Ribbed Drive Pulleys

Clamps onto any ribbed pulley. Suitable for use on crankshafts, alternators, air conditioning units and water pumps.



Install/Remove Gear Belt Tool

Specifically designed for vehicles fitted with the chain driven 1.6/2.0 direct injection petrol engines. These engines are found in the late A, B, CLA, C and E class vehicles. Due to the type of construction used on these engines the camshaft needs to be clamped in place to allow dismantling and assemble of the cylinder head. Designed to allow removal and assembly of the camshafts



Timing Tool Set



Timing Tool Set





The listing of a hand tool must go through multiple processing processes. The precision coordination degree in various processing processes is an important key to the achievement of the quality of hand tools. SUMMIT Enterprise is a related enterprise of HANDILY INDUSTRIAL. In addition to developing its own brand hand tools, it also focuses on the research and development of various processing procedures, so that the hand tools produced by HANDILY and SUMMIT have a place in the world.



“A miss is as good as a mile”SUMMIT is committed to investing in processing equipment Only with more precision processing machines and the overall processing process can we reach the standard in the assembly of various connecting parts of hand tools and achieve an extraordinary hand tool.

E-mail:[summit@sum-mit.com.tw](mailto:summit@sum-mit.com.tw)



For 30+ years, JEOUTAY LIU Industrial Co., Ltd. in Taichung, Taiwan has produced quality tools with competitive pricing. Our extensive product line includes Blades, Bits, Socket Bits, Anti-slip Bits, Auto parts, and Toolsets. All JEOUTAY products are manufactured in-house using over 36 professional-grade lathe, milling, forced, & stamping machines. Each product goes through rigorous quality inspection, ensuring surface finishes, heat treatment, torque, hardness, & dimensions meet industry standards. We work with clients through the stages of design, development, & manufacturing to meet OEM/ODM requirements.

With years of manufacturing experience & ISO 9001 approval, we ensure quality products & timely delivery.



E-mail: [paul@jeoutay.com](mailto:paul@jeoutay.com)



JEOUTAY LIU Industrial Co., Ltd. have a number of patents for screwdriver products. For the development of new products, we always keep ahead of the industry.



E-mail: paul@jeoutay.com



## **HARDWARE TOOLS**

- 1.Tools
- 2.Handtools
- 3.Electrical Tools
- 4.Pneumatic Tools

Clamp various sizes

# PLIER WRENCHES

DWP-10PW

## Features

- Hot forged by Cr-Mo steel. Made to last.
- The jaw allows quick tightening and release of nut like using the ratchet.
- Fast adjustment on the workpiece with press button.
- Smooth jaws without damage during installation.
- Replaces metric and imperial spanners.
- For opening widths up to 46 mm / 1 3/4".



Quick Adjustment



Clamp Tighter

**DAIKEN**<sup>®</sup>  
PLIERS, SINCE 1968

**Daiken Tools Enterprises Co., Ltd.**

No.143, Haolai 1st St., Dali Dist., Taichung City 41242, Taiwan  
Tel: 886-4-22782825 Fax: 886-4-22780572  
sales@daikentools.com



# OEM/ODM

Professional Plastic Air-blowing  
Molding Manufacturer



## Application:

- Auto
- Medical
- Hardware
- Toy
- Sports
- Outdoor Furniture



郁慶塑膠股份有限公司  
YU CHING PLASTICS CO.,LTD.

No. 2, Ln.195, Dalin Rd., Daya Dist.,  
Taichung City 428, Taiwan  
Tel: 886-4-2566-8138  
E-mail: y888.ching@msa.hinet.net  
Https://www.yu-ching.com

# TOOL BOX



Professional Manufacturer

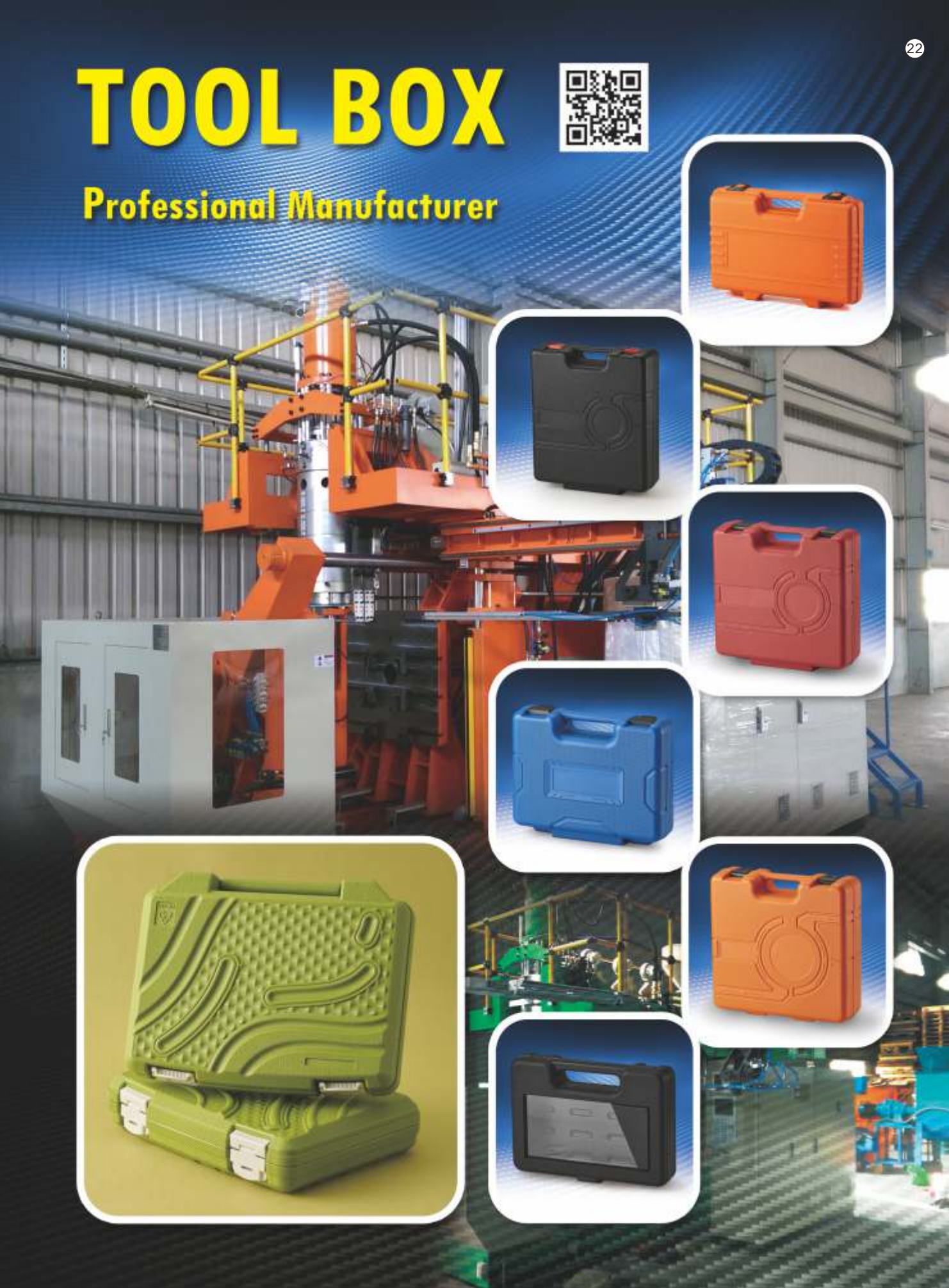

Patented



**HANDILY INDUSTRIAL CO., LTD.**

No. 491, Jun Fu 7th Rd., Taichung 40642, Taiwan

TEL : 886-4-24377229 FAX : 886-4-24377240

E-Mail : handily.co@msa.hinet.net





# SPECIAL AUTOMOTIVE TOOLS

Socket Wrench  
Size: 6"-24"

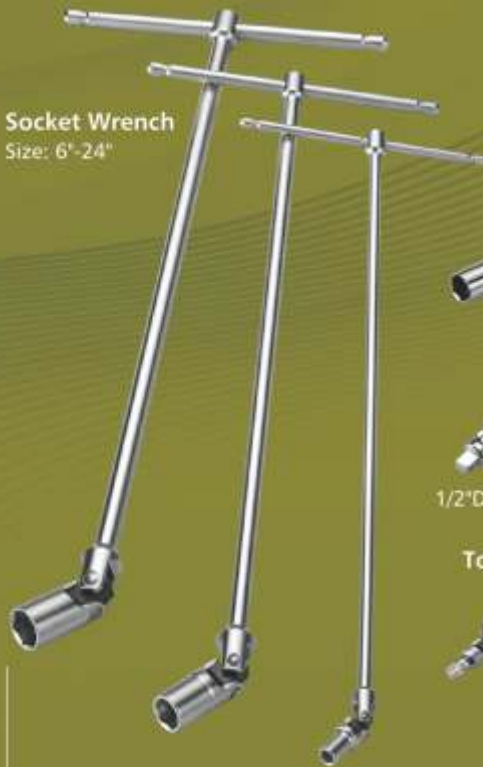

Spark Plug  
Size: 14, 16, 18, 21



Patented



Torx Ends Hexagon Ends



Patented



## SWIVEL T-HANDLE WRENCH



**SM-SUMMIT INDUSTRIAL CO., LTD.**

No.6-29, Dalun Rd., Dacun Township, Changhua County 515, Taiwan

Tel: 886-4-853 6506 Fax: 886-4-852 8567

E-mail: summit@sum-mit.com.tw

# JEOUTAY

## INDUSTRIAL COMPANY

### ABOUT US

For over 30 years, JEOUTAY LIU Industrial Co., Ltd. in Taichung, Taiwan, has produced quality tools. Our extensive product line includes Bits, Socket Bits, Anti-slip Bits, Automotive Tools, Wheel Locks, and Toolsets. All JEOUTAY products are manufactured in-house using over 36 professional-grade lathe, milling, forced, & stamping machines. Each product goes through rigorous quality inspection, ensuring surface finishes, heat treatment, torque, hardness, & dimensions meet industry ISO9001 standards.



## GET IN TOUCH!

### Location

No.31, 12th Road, Da Li Industrial Park  
Da Li District, Taichung, Taiwan 41280

### Web

Paul@jeoutay.com  
www.Jeoutay.com

### Phone Number

+886 4 24914399  
+886 4 24917288

### U.S. Office

Josepons@jeoutay.com  
+1 305 3179872



Scan Here

# AUTOMOTIVE HANDTOOL Manufacturer

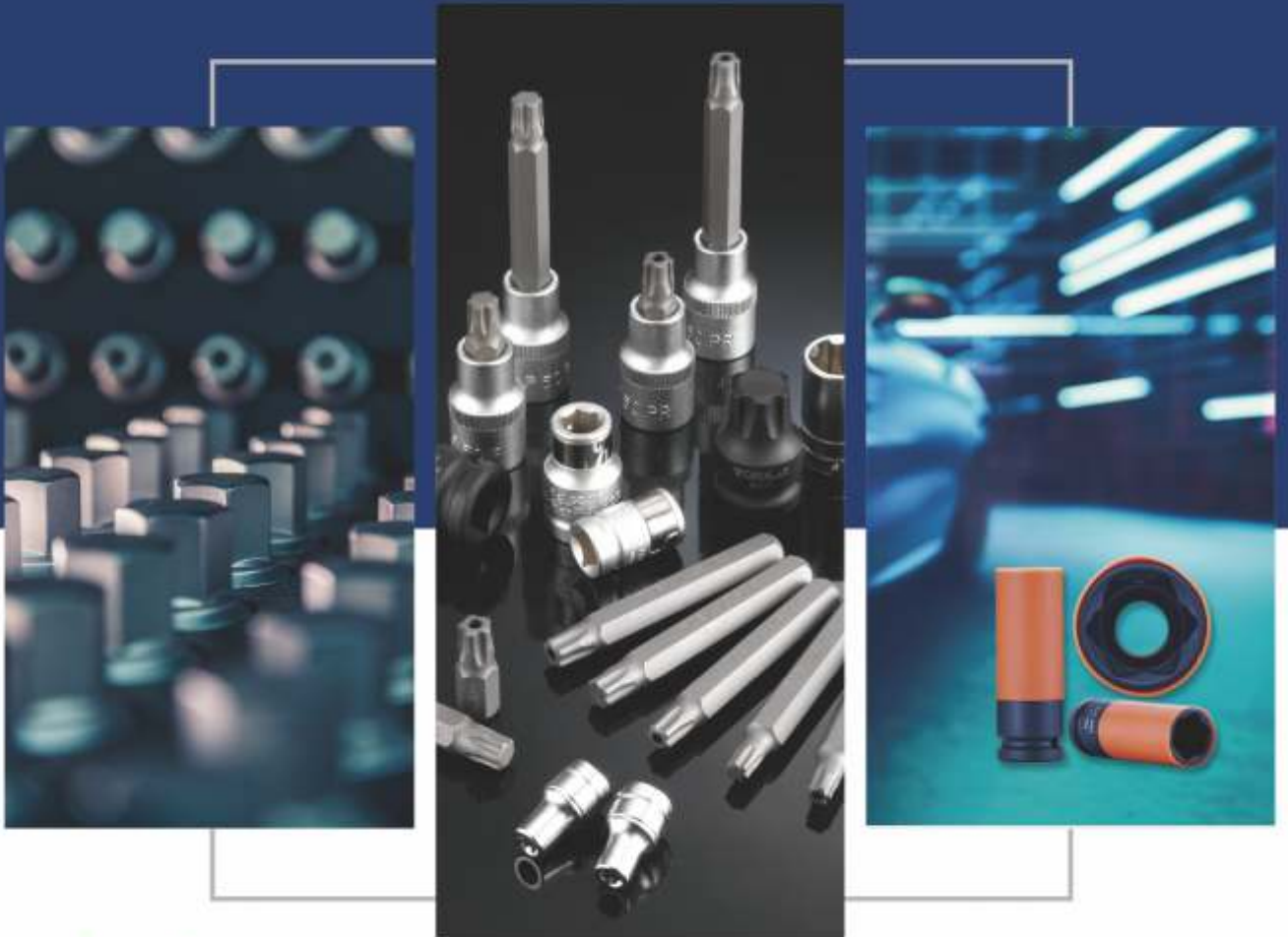

**SEMA2024**  
[WWW.Jeoutay.COM](http://WWW.Jeoutay.COM)



## PLASTIC CASE



Ersson, founded in 1989, is one of the leading manufacturers of plastic case and inlay foam in Taiwan. For over 35 years Ersson has never lost its core value to provide our clients a variety of tool cases and inlay foams with the best solution, quality and services. All products confirm to international standard. Ersson is looking forward to establishing a long term and mutual beneficial partnership with you in the near future.



GT Series  
in 9 sizes



SP Series  
in 29 sizes



TTC Series  
in 7 sizes



AMG Series  
in 11 sizes

## PEVA & XPE Inlay Foam



After many years inlay foam tray development, Ersson has introduced many kinds of surfaces and colors to customers. Patented 3D carbon, metallic skin and shield skin are always popular in the market. To improve material application, PEVA is applied to tool foam tray. For better durability, it is compound of PE and EVA, which gain the benefits of toughness and softness from both materials characteristics.



 3D  
CARBON SKIN  
Patented

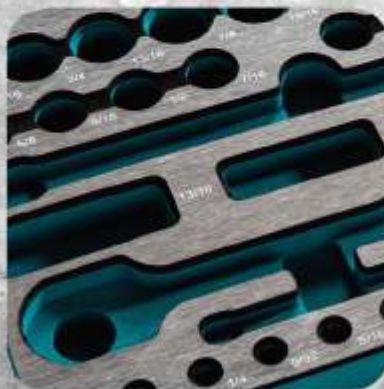

 METALLIC SKIN  
Patented



 SHIELD SKIN



## Product Overview



ANTEAM Orgsystem mainly consists of injection boxes in three different sizes and drawer chest. It consists of 50 and 100mm deep drawers and an upper case. Drawers can be stacked up as a drawer chest or mobile tool trolley. ANTEAM Orgsystem is specially designed for hand tools, power tools or even for the fastener application. It can be used in concert with trolley platform for easy movement. Durable, high quality ABS material provides a long service-life while shared same bottom platform provides easy stacking, storage, and transport to users. Create your own combinations to suit your work.



ANTEAM 078  
OD:456X372X115mm



AT 2 Drawer Tool chest  
OD:496X372X250mm



ANTEAM 120  
OD:456X372X155mm



AT 3 Drawer Tool chest  
OD:496X372X368mm



AT 11 Drawer Tower  
OD:655X490X988mm



ANTEAM 227  
OD:456X372X262mm

### FEATURES

- Impact Resistant Body
- Quick Adjust Dividers
- Self-Latching Drawers
- Metal Ball Bearing Drawer Slides
- Both Sides Pegboard
- Fully Opening Drawers
- Modular Connectivity with All ANTEAM Components



INSERT BOXES





## ■ *Air Rivet Nut Tool*



composite body  
**CCP-20M/U**

Over 3200lbs traction power  
Light weight spin-pull rivet nut setter  
Quick change connector for tie rod  
Set up to 5/16"(M8) stainless steel rivet nuts  
Wear-resistant surface extend tool life  
Rubber grip with soft touch for easy operation  
Stroke 2~7mm



## ■ *Air Riveter Tool*



**CCP-450R/CCP-450HLR**

With suction control switch  
Long stroke(26/30mm)  
Set 5/16"(7.8mm)and 3/16"(4.8mm) Monobolt rivets, "T"rivets and standard rivets-in all materials  
Soft-set shockless tools  
Mandrel collection bottle design allows for easy disposal of spent mandrels  
Heavy duty construction for rugged application  
Durable, lightweight  
Nail back twice as fast, the low pressure operatin



**CHIAO CHANG PNEUMATIC TOOL CORP** is a tool manufacturing company, specializing in the manufacture of high quality (150-9001) tools for distribution in the world-wide market. We design and manufacture air tools professionally. Our major products include heavy-duty hydraulic riveter tools, heavy-duty hydraulic air rivnut tools, air engraving pens, air nibblers, etc.

We have been producing air tools in Taiwan since 1983, and the whole factory passed ISO 9000 authentication. We keep on researching, developing and improving the products constantly. Validated by the CE authentication, our products are made with high quality to satisfy our customers.

## ■ Cordless Riveter

Mandrel-pulling distance sensing assembly of an electric rivet gun  
(U.S. Patent, Taiwan patent)

Quick-change patent design:  
No need open-wrench when  
change or clean jaw set.  
(U.S. Patent, Taiwan patent)

Efficient and convenient design  
for user to maintenance jaw housing  
and change nosepiece.

Patent for ball screw fixing  
assembly of Rivet gun  
(Taiwan patent)

Battery capacity display

Taiwan Patent  
for Electric Rivet Gun  
Transmission Assembly

When encounter bad rivets  
or rivet-jam situation, please reload  
battery and the tool will automatic  
discharge mandrel.



Model	Force	Stroke	Motot Type	Battery	Tool Dimensions	Riveting Capacity
ER-1	5000LBS (22241N)	25mm	Brushless DC	18V 2.0AH 18V 2.6AH 18V 5.2AH	H:306.2mm(12.05") L:307.3mm(12.09") D:70.5mm(2.77") Wt:1.69kg (without battery)	Ø4.8~Ø6.4 all materials (max.mandrel diameter 4.5mm)
ER-2	2500LBS (11120N)	25mm	Brushless DC	18V 2.0AH 18V 2.6AH 18V 5.2AH	H:306.2mm(12.05") L:307.3mm(12.09") D:70.5mm(2.77") Wt:1.68kg (without battery)	Ø2.4, 3.2, 4.0, 4.8(5.0) all materials

EN/UL/CSA 62841-1





T.G & Son Co., Ltd.  
塑贊有限公司



符合ISO14021

Verified Recycled Content :  
ISO 14021:2016 standard certified

EVA & PE 泡棉  
襯墊客製包裝



減塑材料

Plastic reduction  
materials

不會生鏽, 醫療級

Stainless &  
medical grade of foam



無味道  
Smellless



回收  
Recyclable



無甲醯胺  
Formamide Free



碳權  
Applied to  
Carbon Footprint label

No. 2, Wugong 6th Rd., Wufeng Dist., Taichung City 413012, Taiwan

E-mail : scott@tgandson.com

Tel : 886-4-24965969

Fax : 886-4-24965159





## Carbon Fiber Texture Foam / 3D

**Patented**

Patent Number

PAT. D160598  
USD714,120S

EM002259127



Color Printing



PANTONE COLOR



## Brushed Metal Texture Foam / 3D

**Patented**

Patent Number

PAT. D160600



Color Printing



LASER ENGRAVING

- ✓ 精密激光雷射
- ✓ 細緻刻字處理
- ✓ 無須額外開版
- ✓ 設計變幻自如
- ✓ 客製化的服務

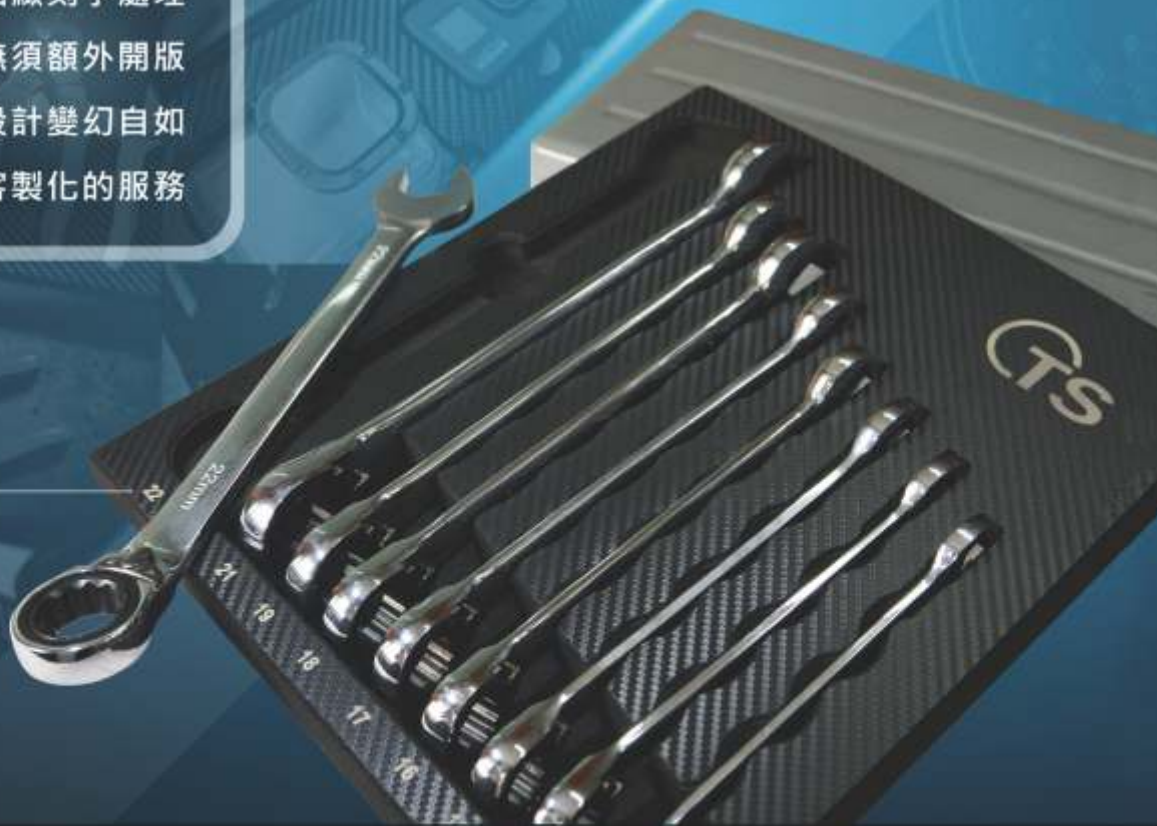

# CORDLESS TOOL GAS POWERED TOOL

*Professional Tools for Soldering, Welding and Brazing.*



All-in-One  
SOLDERING IRON TORCH



2-in-One  
SOLDERING TORCH



HEAVY DUTY  
BLOW TORCH



INVESTA TECHNOLOGY CORP.

Tel: +886-2-22982290 #270 Fax: +886-2-22981892

Email: [kristy.hsu@investa.com.tw](mailto:kristy.hsu@investa.com.tw)

5F.-2, NO.26, WUQUAN 2ND RD., XINZHUANG DIST., NEW  
TAIPEI CITY 242, Taiwan



HOT AIR GUN



SOLDERING IRON



CORDLESS GLUE GUN



Scan to view our product line



# Professional Tools OEM/ODM



# STools

**SHENJOHN TOOLS INDUSTRIAL CO., LTD.**  
No. 538, Junfu 9th Rd., Beitun Dist, Taichung City 40655, Taiwan  
Tel:+886-4-24370858  
E-mail:bruce@sjtools.com.tw



E-catalog

# RATCHET WIRING DUCT CUTTER



## RATCHET WIRING DUCT CUTTER HJ-15

Ideal for cutting wiring duct up to 120 mm. Angle adjustment design.  
Smooth cut surface and accurate angle.

Quickly replace the blade. Easily replaceable Anvil.

Ratchet drive is more labor-saving. Tooth shape meshing longitudinal feed,  
automatically lock when cutting safe and non-rebound.

ITEM NO.	HJ-15
DIMENSIONS	L320 x W110 x H85 MM
COLOR	Blue, Red, Yellow, Green, Orange
MATERIALS	Body plate : Steel(Steel Plate Cold Commercial), Chrome plating Blade : Carbon tool steel SK5, Chrome plating, Heat treating Anvil : Aluminum alloy Ratchet : Carbon tool steel SK5, Black oxide Handle : TPR, PP

APPLICATION Cable duct, PVC wiring duct, etc.

CUTTING RANGE Width maximum 120MM, Angle adjustable 45°-135°

## HMIT TRADING CO.

13F-5, No.100, Sec. 1, Zhongqing Rd., North Dist.,  
Taichung City 404, Taiwan

TEL:886-4-8535499 FAX:886-4-22083823

E-mail:hmitivy@gmail.com

[Http://www.cable-tie.com.tw](http://www.cable-tie.com.tw)





# SUPPLIERS DIRECTORY

- 1.Tools
- 2.Handtools
- 3.Electrical Tools
- 4.Pneumatic Tools



**JOHNSON TOOLS CO., LTD.**  
 No. 83, Lane 22, Xinren Rd., Sec. 1, Taiping Dist.,  
 Taichung City, Taiwan 41143  
 Tel:886-4-2279-8181  
 Fax:886-4-2277-0728  
 E-mail:johnson.tools@msa.hinet.net  
[Http://www.johnson-ytc.com](http://www.johnson-ytc.com)

**Product:Handtools**



**T.G & SON CORP. LTD.**  
 No.2, Wugong 6th Rd., Wufeng Dist.,  
 Taichung City 413012, Taiwan  
 Tel:+886-4-2496-5969  
 Fax:+886-4-2496-5159  
 E-mail:scott@tgandson.com  
[Http://www.tgandson.com](http://www.tgandson.com)

**Product:Eva Foam**



**ERSSON INTERNATIONAL**  
 No.16, Lane 15, Heli St., Taiping Dist.,  
 Taichung City 411, Taiwan  
 Tel:+886-4-22775909  
 Fax:+886-4-22771991  
 E-mail:info@ersson.com.tw  
[Http://www.ersson.com.tw](http://www.ersson.com.tw)

**Product:Bmc&Eva**



**JEOUTAY LIU INDUSTRIAL CO., LTD.**  
 No.31, 12th Rd., Da Li Industrial Park, Da Li Dist.,  
 Taichung City, Taiwan 41280  
 Tel:+886-4-24914399  
 Fax:+886-4-24914366  
 E-mail:paul@jecutay.com  
[Http://www.jeoutay.com](http://www.jeoutay.com)

**Product:Tools**



**LNTOOL INDUSTRIAL CO.,LTD.**  
 No.26, Lane 213, Fuya Rd., Situn Dist.,  
 Taichung City, Taiwan  
 Tel:+886-4-24618959  
 Fax:+886-4-24619539  
 E-mail:service@lntool.com.tw  
[Http://www.lntool.com.tw](http://www.lntool.com.tw)

**Product:Tools**



**DAIKEN TOOLS ENTERPRISES CO., LTD.**  
 No.143, Hou-La, 1st Lane, Tali Dist., Taichung City 412, Taiwan  
 Tel:+886-4-22782825  
 Fax:+886-4-22780572  
 E-mail:sales@daikentools.com  
[Http://www.daikentools.com](http://www.daikentools.com)

**Product: Plier Wrenches**

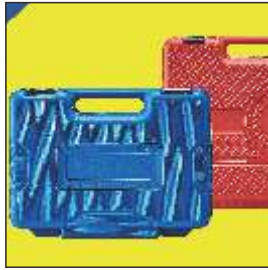

**YU CHING PLASTICS CO., LTD.**  
 No.2,Ln.195,Dalin Rd.,Daya Dist.,Taichung City 42847, Taiwan  
 Tel:+886-4-25668138  
 Fax:+886-4-25672723  
 E-mail:y888.ching@ms16.hinet.net  
[Http://www.yu-ching.com](http://www.yu-ching.com)

**Product:Tool Box.Telescopic Plastic Box**



**CHIAO CHANG PNEUMATIC TOOL CORP.**  
 N1F., No. 159, Sec. 2, Datong Rd., Xizhi Dist.,  
 New Taipei City 221, Taiwan  
 Tel:+886-2-86926800  
 Fax:+886-2-86926804  
 E-mail:info@ccp-tw.com.tw  
[Http://www.ccptool.com](http://www.ccptool.com)

**Product: Riveter Tools**



**MANOR HARDWARE CORPORATION**  
 No.38, Ln. 188, Kungyeh Rd., Lung Jin  
 Dist., Taichung City 43445, Taiwan  
 Tel:+886-4-2639-9856  
 Fax:+886-4-26305833  
 E-mail:magnum@ms12.hinet.net  
[Http://www.manortools.com.tw](http://www.manortools.com.tw)

**Product:Handtools**



**SHENJOHN TOOLS INDUSTRIAL CO., LTD.**  
 No. 538, Junfu 9th Rd., Beitun Dist, Taichung City 40655, Taiwan  
 Tel:+886-4-24370858  
 E-mail:bruce@sjtools.com.tw  
[Http://hmit.com.tw/ebook](http://hmit.com.tw/ebook)

**Product:Test Tools, Auto Repair Tools**



**TAIWAN COUNTER INDUSTRY CO., LTD.**  
 No.79-1, Lane 210, Dong Shan Rd.,  
 Beitun Dist., Taichung City, Taiwan 40641  
 Tel:+886-4-24372057  
 Fax:+886-4-24372097  
 E-mail:counter.tci1281@msa.hinet.net  
[Http://www.tci-counter.com](http://www.tci-counter.com)

**Product:Measuring Wheel**



**EVERPRO INTERNATIONAL CORP**  
 No.28,Yongfu Street,Taiping Dist.,Taichung City,  
 41154 Taiwan  
 TEL:+886-4-22797228 FAX:+886-4-22798180  
 E-mail:eprotool@ms79.hinet.net  
[Http://www.eprotool.com.tw](http://www.eprotool.com.tw)

**Product:EZ SPRAY HANDLE GRIP**



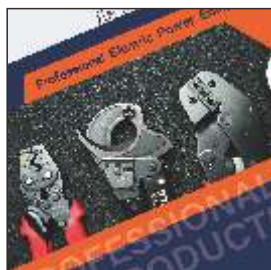

**TELEANTOOL CO., LTD.**  
 No.19-39, Lane 50, Xinxiang St., Sec. 1, East Dist.,  
 Hsinchu City 300, Taiwan  
 Tel:886-3-5278748  
 Fax:886-3-5278754  
 E-mail: tla@teleantool.com  
[Http://www.teleantool.com](http://www.teleantool.com)

**Product:Electric tools**



**HUNG CHANG TOOLS CO., LTD.**  
 No.6-23, Ln.31, Dali St., Dali Dist., Taichung 412024, Taiwan  
 TEL:+886-4-24066810  
 FAX:+886-4-24064801  
 E-mail: hctools.sean@gmail.com      info@hc-flaring.com  
[Http://www.flaring.com.tw](http://www.flaring.com.tw)  
[www.hungleader.com](http://www.hungleader.com)  
[www.flaringtool.com.tw](http://www.flaringtool.com.tw)

**Product:Scraper/Flaring tools**



**HOTERY PRODUCTS CORP.**  
 5F.-2, No. 26, Wuquan 2nd Rd., Xinzhuang Dist.,  
 New Taipei City 24892, Taiwan  
 TEL:+886-2-22982290  
 FAX:+886-2-22981892  
 E-mail: kristy.hsu@investa.com.tw  
<https://www.gas-torch.com/>

**Product: Gas powered tool/cordless tool**



**HONG JIN HARDWARE CORPORATION**  
 No.14, Ln. 461, Pengyi Rd., Taiping Dist.,  
 Taichung City 411, Taiwan  
 Tel:886-4-2276-7140  
 Fax:886-4-2275-8163  
 E-mail: hongjin461@gmail.com  
[Http://www.mitre-cutters.com](http://www.mitre-cutters.com)

**Product:Tube Straightener**



**TQ CUTTING TOOL INDUSTRIAL CO.,LTD.**  
 No.130, Gongye 11th Rd., Dali Dist.,  
 Taichung City 41280, Taiwan  
 Tel:+886-4-24915355  
 Fax:+886-4-24915177  
 E-mail: jennyz@tqcutting.com.tw  
[Http://www.tqcutting.com.tw](http://www.tqcutting.com.tw)

**Product:Rotary Burrs, Step Drills**



**ALWAYS GREEN CO.,LTD.**  
 No.9, Lane 37, Tienyi St., E. Dist., Taichung City, Taiwan  
 Tel:+886-4-22805382  
 Fax:+886-4-22805411  
 E-mail: wisdomlin@yahoo.com.tw  
[Http://www.punchamtools.com](http://www.punchamtools.com)

**Product:Pneumatic Tools**



**FERRO-CARBON ENT. CO., LTD.**  
 No.20, Jing 1st. Rd., Sec. 1, Taichung Part Technology Industrial Park,  
 Wuqi Dist., Taichung City 43541, Taiwan  
 Tel: +886-4-26595889  
 Fax: +886-4-26595881  
 E-mail: service@ferro-carbon  
[Http://www.ferro-carbon.com](http://www.ferro-carbon.com) [www.feca.com.tw](http://www.feca.com.tw)

**Product: Tile Cutter**



**LIU HUNG INDUSTRIAL CO., LTD.**  
 No.10, 11th Rd., Taichung Industrial Park, Dali Dist.,  
 Taichung City 41280, Taiwan  
 Tel: +886-4-23593800  
 Fax: +886-4-23591817  
 E-mail: info@hexatool.com.tw  
[Http://www.hexatool.com.tw](http://www.hexatool.com.tw)

**Product: Tools**



**JUST WELL MACHINERY INDUSTRIAL CO., LTD.**  
 No.88, Dazhou Rd., Shengang Dist.,  
 Taichung City 42941, Taiwan  
 Tel: +886-4-25279945  
 Fax: +886-4-25279947  
 E-mail: sales.c@justwell.com  
[Http://www.justwell.com](http://www.justwell.com)

**Product: Tools**



**DONZEE ENTERPRISE LTD.**  
 No.18, Ln. 301, Fengzhou Rd., Shengang Dist.,  
 Taichung City 42945, Taiwan  
 Tel: +886-4-25236933  
 Fax: +886-4-25295255  
 E-mail: info@donzee.com  
[Http://www.donzee.com](http://www.donzee.com)

**Product: Ridof Wipes**



**TOP-LONG INDUSTRIAL CO., LTD.**  
 5F-1, No.128, Sec.3, Chongxin Rd., Sanchong Dist.,  
 New Taipei City 241, Taiwan  
 Tel: +886-2-29758315  
 Fax: +886-2-29758351  
 E-mail: victoria@topleng.com.tw  
[Http://www.toplong.com.tw](http://www.toplong.com.tw)

**Product: Measuring Tools**



**SAME YONG INDUSTRIAL CO., LTD.**  
 5No. 117, Meiqun North Road, Dali District, Taichung City, Taiwan  
 Tel: +886-4-2483-4322  
 Fax: +886-4-2493-9117  
 E-mail: sales@unitacker.com.tw unitacker@gmail.com  
<http://www.unitacker.com.tw>

**Product: Staple guns, Stamping parts**



**WINLAND GARDEN TOOLS CO., LTD.**  
 No. 30, Min Yu St., Lukang Township, Changhua County 50545, Taiwan  
 Tel: +886-4-7778139  
 Fax: +886-4-7778739  
 E-mail: winland@winland-garden.com.tw  
[Http://www.winland-garden.com.tw](http://www.winland-garden.com.tw)

**Product: Garden Tools**



**PUMA INDUSTRIAL CO., LTD.**  
 No. 427, Sec. 2, Doujiong Rd., Tianjiong Township,  
 Changhua County 52046, Taiwan  
 Tel: +886-4-8752101  
 Fax: +886-4-8744766  
 E-mail: arthur.h@pumaair.com  
[Http://www.pumaair.com](http://www.pumaair.com)

**Product: Pneumatic Tools**





# **Building Hardware & Furniture Hardware**

## **Bathroom Fittings & Equipment**



# SGE®



## SGE TERMINALS & WIRING ACCESSORIES INC.

No.12, Ln. 194, Zhang Shui Rd., Changhua City,  
Changhua County 500031, Taiwan  
Tel:+886-4-7631366 Fax:+886-4-7632100  
E-mail:sales@sge.com.tw  
[www.sgeterminals.com](http://www.sgeterminals.com)



(Patented)

**NEW**

UL<sup>®</sup> cUL<sup>®</sup> RoHS  
ISO 9001



# SAFETY. QUALITY. TRUST

The world's first and lightest design from Ferro-Carbon



**FERRO-CARBON**



**FERRO-CARBON ENT.CO., LTD**

Tel:886-4-26595889 | Fax:886-4-26595881 | Email:service@feca.com.tw

No.20, Jing 1st Rd., Chungkang Export Processing Zone Wuqi Dist,  
Taichung City 43541, Taiwan

[www.feca.com.tw](http://www.feca.com.tw) | [www.ferro-carbon.com](http://www.ferro-carbon.com)









# FECA

## Super Power NO.1 Suction System

FECA stylish and tool-free design provides the storage convenience. It can keep the firm steady because of its unique strong suction. Let FECA be your space magic.

### Features

-  No drilling, no nails.
-  Reliable suction power.
-  Easy adjustable and reusable.
-  Waterproof.
-  For rough surface (under 0.4mm)
-  Temperature resistance from -10°C to 70°C.



#### FERRO-CARBON ENT.CO., LTD

Tel:886-4-26595889 | Fax:886-4-26595881 | Email:service@feca.com.tw  
No.20, Jing 1st Rd., Chungkang Export Processing Zone Wuqi Dist,  
Taichung City 43541, Taiwan  
[www.feca.com.tw](http://www.feca.com.tw) | [www.ferro-carbon.com](http://www.ferro-carbon.com)





# CYUN HONG

## HARDWARE CASTER

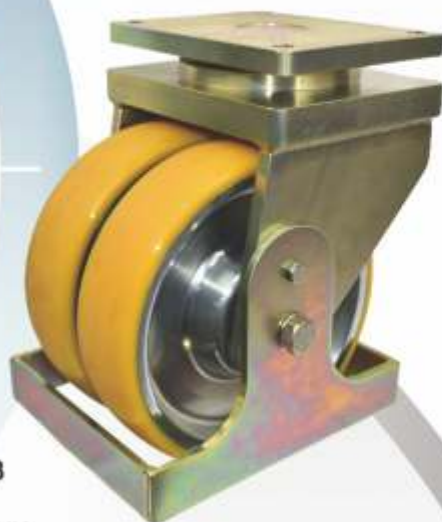

### 群弘興業有限公司

### CYUN HONG Enterprise Co., Ltd.

**Kaohsiung Office:**  
 No. 5, Aly. 5, Ln. 267, Sec. 3, Jianguo Rd.,  
 Fengshan Dist., Kaohsiung City 830, Taiwan  
 E-mail: [ch.casters@msa.hinet.net](mailto:ch.casters@msa.hinet.net)  
<http://www.chcaster.com>

**Taichung Office:**  
 No. 10-12, Yonghe Rd., Daya Dist., Taichung City, Taiwan 428  
 Tel: 886-4-2565-2102~3 Fax: 886-4-2565-2735  
 E-mail: [ch.casters@gmail.com](mailto:ch.casters@gmail.com) <http://www.ch-caster.com>  
[ch.sales1@chcasters.com](mailto:ch.sales1@chcasters.com) [www.ch-casters.com](http://www.ch-casters.com)  
[ch.sales2@chcasters.com](mailto:ch.sales2@chcasters.com)





### Hand Truck/Cart/Trolley Series



Japanese type floor lock



PQR



PNS



HP-114



AL-20-127-B



A-42-B

### Adjustable Foot Series



CH020



E001



E004



E006



Z005



Z009



Z010



Z013

### Trolley Series



Stainless steel platform trolley



Plastic platform trolley



Foldable platform trolley

## 群弘興業有限公司 CYUN HONG Enterprise Co., Ltd.

Kaohsiung Office:  
No. 5, Aly. 5, Ln. 267, Sec. 3, Jianguo Rd.,  
Fengshan Dist., Kaohsiung City 830, Taiwan  
E-mail: [ch.casters@msa.hinet.net](mailto:ch.casters@msa.hinet.net)  
<http://www.chcaster.com>

Taichung Office:  
No. 10-12, Yonghe Rd., Daya Dist., Taichung City, Taiwan 428  
Tel: 886-4-2565-2102~3  
E-mail: [ch.casters@gmail.com](mailto:ch.casters@gmail.com)  
[ch.sales1@chcasters.com](mailto:ch.sales1@chcasters.com)  
[ch.sales2@chcasters.com](mailto:ch.sales2@chcasters.com)

Taichung City, Taiwan 428  
Fax: 886-4-2565-2735  
<http://www.ch-caster.com>  
[www.ch-casters.com](http://www.ch-casters.com)



# Uniplumbg Enerprise Co., Ltd.

Quality Plumbing and EOM Products  
SINCE 1984



Your Success,  
Our Commitment

[www.upetwn.com](http://www.upetwn.com)

三提企業有限公司 Uniplumbg Enerprise Co., Ltd.

40756 台中市西屯區市政北七路98號5樓之2  
5B, No. 98, Shizheng N. 7th Rd., Xitun Dist.,  
Taichung 40756, Taiwan

Tel: 886-4-22593500 Fax: 886-4-22593510

E-mail: [upetwn@ms7.hinet.net](mailto:upetwn@ms7.hinet.net)

# Customized and Quality

## MADE FOR YOU

- TURNING PARTS
- INVESTMENT CASTING
- ALUMINUM & ZINC PARTS
- SAND CASTING & FORGING



## UNIPLUMBG 6 SERVICES

- SUPPLY CHAIN
- INVENTORY
- SHIPPING CONSOLIDATION
- GLOBAL SOURCING
- ON-SITE INSPECTION
- PROJECT MANAGEMENT



三提企業有限公司 Uniplumbg Enerprise Co., Ltd.

40756 台中市西屯區市政北七路98號5樓之2  
 5B, No. 98, Shizheng N. 7th Rd., Xitun Dist., Taichung 40756, Taiwan  
 Tel: 886-4-22593500 Fax: 886-4-22593510  
 E-mail: upetwn@ms7.hinet.net



# FLOOR SPRING

www.gacity.com.tw

## FEATURES:

- \*Suitable for single & double action doors.
- \*Maximum door width 1400mm, Maximum door weight 300kg, Maximum door opening 180°.
- \*Available for no hold open of fire doors.
- \*The closing speed range 180°~20°.
- The latching speed range 20°~0°.
- \*Back check function.
- \*The spring force is fixed number of option.

S280

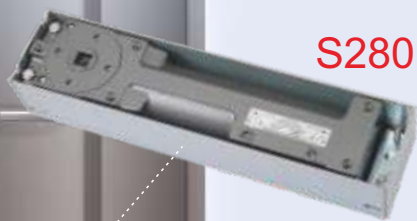

LOAD  
**300kg**

S200

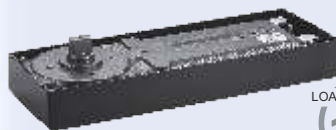

LOAD  
**120kg**

Accessories

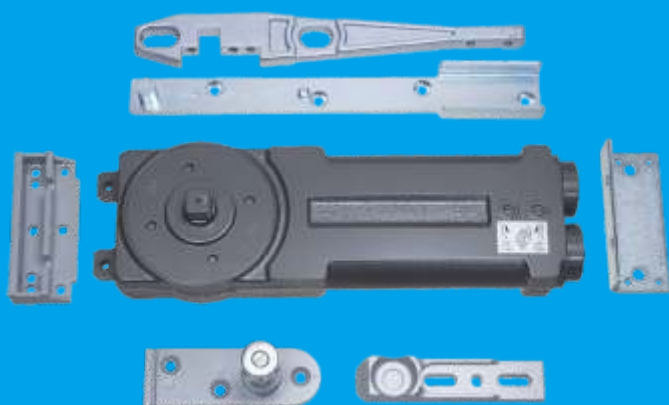
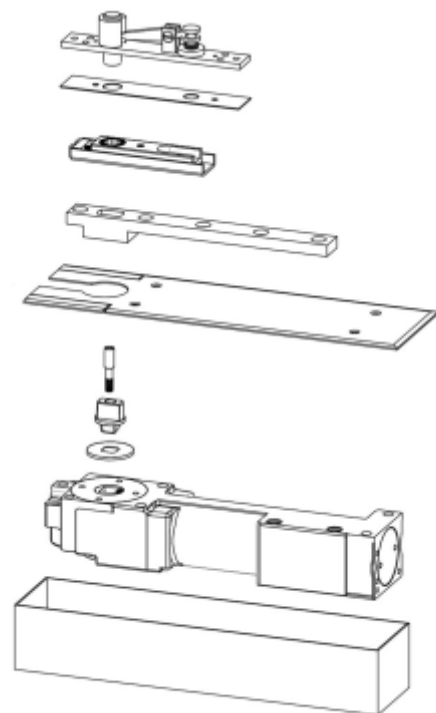

T500E

## FEATURES:

- \*Suitable for single & double action doors.
- \*Maximum door weight 100kg.
- \*The speed adjustment valves can not be backed out of transom closer when adjustment, that eliminates oil leakage from the valves.
- \*Adjustment valves of closing speed and latching speed are fully independent.
- \*The extended spindle can be lengthened 5mm and 10mm.

**GACITY INDUSTRIAL CO., LTD.**

No.5-21, Wa Tsai Road, Hualun Village, Erh Lin Town, Changhua, Taiwan

TEL:886-4-8685072 FAX:886-4-8685071

E-mail:hardware@gacity.com.tw



# Agricultural Scaffold Connectors ductile iron casting joints

[www.gacity.com.tw](http://www.gacity.com.tw)

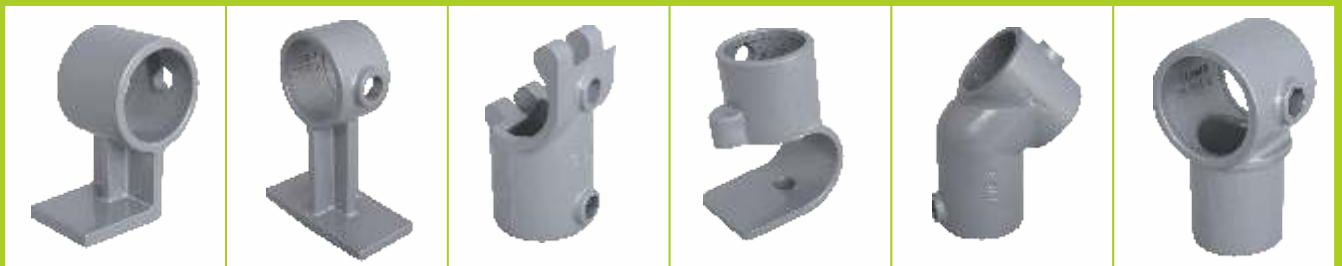

**GACITY INDUSTRIAL CO., LTD.**

No.5-21, Wa Tsai Road, Hualun Village, Erh Lin Town, Changhua, Taiwan

TEL:886-4-8685072 FAX:886-4-8685071

E-mail:[hardware@gacity.com.tw](mailto:hardware@gacity.com.tw)





# DIY FOLDING DOOR



## Zhaopeng

Plastic Building Materials & Metal Co., Ltd.

4Fl., No. 10-1, Heping Rd., Banciao Dist.,  
New Taipei City 22061, Taiwan

Tel: 886-2-2961-4509 Fax: 886-2-2961-2088

E-mail: zp.plastic@gmail.com

<http://www.zp-plastic.com>





# DIY BRAN DOOR



## Zhaopeng

Plastic Building Materials & Metal Co., Ltd.

4Fl., No. 10-1, Heping Rd., Banciao Dist.,

New Taipei City 22061, Taiwan

Tel: 886-2-2961-4509

Fax: 886-2-2961-2088

E-mail: zp.plastic@gmail.com

<http://www.zp-plastic.com>



# HARDWARE BRUSH

Stainless steel brush, Copper brush, Nylon brush



**YI-FA** YI-FA PROCESSING FACTORY

No. 29, Lane 897, Minsheng S. Rd., Chiayi City 600, Taiwan  
Tel: 886-5-2353657 Fax: 886-5-2360127

E-mail: yifa657@gmail.com  
E-mail: yifa657@ms78.hinet.net  
http://www.yifa-brush.com





# Building Hardware Window & Door Hardware



Profession Die Casting



Ball Catch

OEM

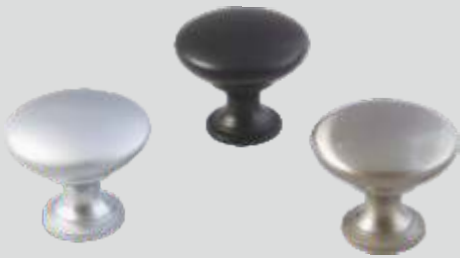

Handle



Zinc Alloy

ODM



Sliding Door Handle



flush bolt



Door Stop



**U-HOUSE HARDWARE INDUSTRY CO., LTD.**

Tel:+886-4-7363879 | Fax:+886-4-7367352

No.206, Kedong Rd., Hemei Township,  
Changhua County 508, Taiwan

E-mail:yocheng168@gmail.com



[Http://www.uhouse-hardware.com](http://www.uhouse-hardware.com)



No. 48, Gongye 20th Rd. Taiping Dist.,  
Taichung City 411014, Taiwan  
Tel: 886-4-24064893 | Fax: 886-4-24071762  
Email: [tony@bbest-tech.com.tw](mailto:tony@bbest-tech.com.tw)  
<https://bbest.en.taiwantrade.com/>





*Tube Laser Cutting*



*Welding*



*Fiber Laser Cutting*



*Powder Coating*

- Slatted Panel System
- Slotted Upright Post System
- Pegboard System

- Display Stands
- Metal Fabrication
- OEM / ODM





# SUPPLIERS DIRECTORY

building hardware &  
furniture hardware

Bathroom fittings &  
Equipment





**BBEST STORE FIXTURES CO., LTD.**  
 No. 487, Sec., 3, Zhongtuo W. Rd., Dali Dist.,  
 Taichung City, Taiwan  
 Tel. +886 4 2406 4893  
 Email:sales@bbest-tech.com.tw  
<https://www.bbeststorefixtures.com/>

**Product: Feature Display Rail**



**U-HOUSE HARDWARE INDUSTRY CO., LTD.**  
 No.206, Kedong Rd., Hemei Township,  
 Changhua County 508, Taiwan  
 Tel:+886-4-7363879  
 Fax:+886-4-7367352  
 E-mail:yocheng168@gmail.com  
[Http://www.uhouse-hardware.com](http://www.uhouse-hardware.com)

**Product:Building Hardware**



**HOTERY PRODUCTS CORP.**  
 5F.-2, No. 26, Wuquan 2nd Rd., Xinzhuang Dist.,  
 New Taipei City 24892, Taiwan  
 TEL:+886-2-22982290  
 FAX:+886-2-22981892  
 E-mail:kristy.hsu@investa.com.tw  
<https://www.gas-torch.com/>

**Product: Gas powered tool/cordless tool**



**FU IN C. M. ENTERPRISE CORPORATION**  
 No. 27, Ln. 40, Sec. 1, Zhongshan Rd., Huatan Township,  
 Changhua County 50343, Taiwan  
 TEL:+886-4-7872997  
 FAX:+886-4-7871987  
 E-mail:info@fuindh.com  
<https://www.fuindh.com/>

**Product:Handle**



**YI FONG IND. SAFETY PRODUCTS CO., LTD**  
 No. 105, Ln. 416, Sec. 2, Yaofeng Rd., Puxin Township,  
 Changhua County, Taiwan  
 Tel: 886-4-8285900  
 Fax: 886-4-8285903  
 E-mail:kaiyo7@yahoo.com.tw;kaiyokae@gmail.com  
[Http://www.kai-yo.com/](http://www.kai-yo.com/)

**Product:Safety Products**



**HUNG CHANG TOOLS CO., LTD.**  
 No.6-23,Ln.31,Dali St.,Dali Dist.,Taichung 412024,Taiwan  
 TEL:+886-4-24066810  
 FAX:+886-4-24064801  
 E-mail:hctools.sean@gmail.com info@hc-flaring.com  
[Http://www.flaring.com.tw](http://www.flaring.com.tw)  
[www.hungleader.com](http://www.hungleader.com)  
[www.flaringtool.com.tw](http://www.flaringtool.com.tw)

**Product:Scraper/Flaring tools**



**CHING SHENGER CO., LTD.**  
 No. 130, Lane 217, Chungyang Rd., Sec. 3, Yupu Village,  
 Hsienhsi Township, Changhua County, Taiwan 507  
 Tel:886-4-758-1484,886-4-758-3627  
 Fax:886-4-758-2756  
 E-mail:carol.luo@cs1985.com.tw  
[Http://www.kinglee1985.com](http://www.kinglee1985.com)

**Product:Faucet**



**WIN CHANCE METAL CO., LTD**  
 No.15-10, Lane 142 Sec.5 Changnan Rd. ,  
 Changhua City, Changhua 50088, Taiwan  
 Tel: + 886-4-7382460  
 Fax: + 886-4-7388180  
 E-mail:info@winchance.tw  
[Http://www.hooksnet.com.tw](http://www.hooksnet.com.tw)

**Product:Ratchet Buckle**



**UNIPLUMBG ENTERPRISE CO., LTD.**  
 5F.-2, No. 98, Shizheng N. 7th Rd., Xitun Dist.,  
 Taichung City 407, Taiwan  
 Tel:+886-4-22593500  
 Fax:+886-4-22593510  
 E-mail:jimyang@upetwn.com  
[Http://www.upetwn.com](http://www.upetwn.com)

**Product:Bathroom Fitting/OEM&ODM**



**SUNRISE PRODUCTS CO., LTD.**  
 26 Kungchu 3rd., Fangyuan Township,  
 Changhua County, Taiwan 52861  
 Tel:+886-4-8965128  
 Fax:+886-4-8963083  
 E-mail:s8965128@ms67.hinet.net  
[Http://www.showerhead.com.tw](http://www.showerhead.com.tw)

**Product:Shower Head**



**EVERFLOW INDUSTRIAL SUPPLY CORP.**  
 16F,No.401,Chung Shan Rd.,Sec. 1,Changhua City,  
 50058 Taiwan  
 Tel:+886-4-7623200  
 Fax:+886-4-7627741  
 E-mail:nbd@everflowind.com  
[Http://www.everflowgroup.com.tw](http://www.everflowgroup.com.tw)

**Product:faucet.Brass Ware.plastic Ware.zinc Ware.blow Injection**



**SCREW KING CO.,LTD**  
 NO.151,Lane1,Sec.3,Wenchang Rd.,  
 Chengkung Borough.Dadu Dist,Taichung City,Taiwan  
 TEL:+886-4-26981986.26981586  
 FAX:+886-4-26998199  
 E-mail:jinjing.a2@msa.hinet.net  
[Http://www.screwking.com.tw](http://www.screwking.com.tw)

**Product:Self Drilling Screw**



**YI-FA PROCESSING FACTORY**  
 No.29, Ln. 897, Minsheng S. Rd., West Dist.,  
 Chiayi City 600, Taiwan  
 TEL:+886-5-2353657  
 FAX:+886-5-2360127  
 E-mail:yifa657@ms78.hinet.net  
[Http://www.yihfa-brush.com](http://www.yihfa-brush.com)

**Product:Brush**



**ZHENG LONG PLASTICS FACTORY CO., LTD.**  
 No.8,Heli St.,Taiping Dist.,Taichung City,  
 Taiwan 411  
 TEL:+886-4-22703754  
 FAX:+886-4-22766553  
 E-mail:zl@zl-cabletie.com  
[Http://www.zl-cabletie.com](http://www.zl-cabletie.com)

**Product:Cable Tie**



**ZHAOPENG PLASTIC BUILDING MATERIALS & METAL CO., LTD.**  
 4f, No.10-1 Hoping Rd., Banciao Dist., New Taipei City,  
 22061, Taiwan  
 TEL:+886-2-29614509  
 FAX : +886-2-29612088  
 Email : zp.plastic@gmail.com  
<https://www.zp-plastic.com>

**Product:Diy Bran Door**



**JOY HARDWARE IND. CO.,LTD.**  
 No. 222 Chungchao street, Changhua,  
 Taiwan, 50344  
 TEL:+886-4-7873420. +886-4-7874369.  
 FAX:+886-4-7875290. +886-4-7874363  
 E-mail:tomwu1017@joy-hardware.com.tw  
[Http://www.joy-hardware.com.tw](http://www.joy-hardware.com.tw)

**Product:Handle.Hurniture Fittings**



**Y.H CASTER CO., LTD**  
 No.42, Ln.251, Kouzhuang St.,  
 Huatan Township, Changhua County 50353, Taiwan  
 Tel:+886-4-763 7070  
 Fax:+886-4-763 7080  
 E-mail:service@yhcaster.com  
[Http://www.yhcaster.com](http://www.yhcaster.com)

**Product:casters**



**JIA HUNG ENTERPRISE CO., LTD.**  
 No. 77, Chipan Lane, Gochien Li, Lukang Town,  
 Changhua County, Taiwan 505  
 Tel:886-4-777-9606  
 Fax:886-4-4-777-0406  
 E-mail:jiahung@jiahung.com  
[Http://www.jiahung.com](http://www.jiahung.com)

**Product: Storage.Plastic Products**



**YNX CHING ENTERPRISE CO., LTD.**  
 No. 50-1, Shangshan 1st Rd., Daya Dist.,  
 Taichung City, Taiwan 42878  
 Tel:+886-4-2567-4668  
 Fax:+886-4-2567-1708  
 E-mail:ynx.ching@msa.hinet.net  
[Http://www.hose-clamp.com.tw](http://www.hose-clamp.com.tw)

**Product:Hose clamp**



**CYUN HONG ENTERPRISE CO., LTD.**  
 No. 10-12, Yonghe Rd., Daya Dist.,  
 Taichung City, Taiwan 428  
 Tel:+886-4-2565-2102~3  
 Fax:+886-4-2565-2735  
 E-mail:ch.casters@gmail.com  
[Http://www.ch-casters.com](http://www.ch-casters.com)

**Product:Casters**

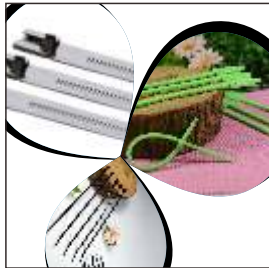

**HMIT TRADING CO.**  
 13F-5, No.100, Sec. 1, Zhongqing Rd., North Dist.,  
 Taichung City 404, Taiwan  
 TEL:+886-4-8535499  
 FAX:+886-4-22083823  
 E-mail:hmitivy@gmail.com  
[Http://www.cable-tie.com.tw](http://www.cable-tie.com.tw)

**Product: Cable-tie**



**SGE TERMINALS & WIRING ACCESSORIES INC.**  
 No.12, Ln 194, Zhang Shui Rd., Changhua City,  
 Changhua County, Taiwan 500031  
 Tel:+886-4-7631366  
 Fax:+886-4-7632100  
 E-mail:sales@sge.com.tw  
[Http://www.sgeterminals.com](http://www.sgeterminals.com)

**Product:Terminals**



**HONG YU SANITARY CO., LTD.**  
 No. 10, Ln. 231, Haiming St., Lukang Township,  
 Changhua County 50562, Taiwan  
 Tel:+886-4-7781029  
 Fax:+886-4-7778959  
 E-mail:hybrasses@gmail.com  
[Http://www.hybrasses.com](http://www.hybrasses.com)

**Product:Bathroom fitting&Brass piping**

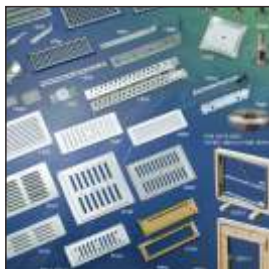

**GACITY INDUSTRIAL CO., LTD.**  
 No.5-21, Wa Tsai Rd., Hualun Village,  
 Erh Lin Town, Changhua, Taiwan  
 Tel:+886-4-8685072  
 Fax:+886-4-8685071  
 E-mail:hardware@gacity.com.tw  
[Http://www.gacity.com.tw](http://www.gacity.com.tw)

**Product:Diy&Building Hardware**





Dayjiuh Industrial Co., Ltd  
 No.146-2, Ln. 121, Sec. 3, Zhongshan Rd.,  
 Changhua City, Changhua County 500, Taiwan  
 Tel:+886-4-7235588  
 Fax:+886-4-7239933  
 E-mail:info@dayjiuh.com.tw  
[Http://www.dayjiuh.com.tw](http://www.dayjiuh.com.tw)

**Product:Cabinet/Architectural Hardware**



TAIWAN COUNTER INDUSTRY CO., LTD.  
 No.79-1, Lane 210, Dong Shan Rd.,  
 Beitun Dist., Taichung City, Taiwan 40641  
 Tel:+886-4-24372057  
 Fax:+886-4-24372097  
 E-mail:counter.tci1281@msa.hinet.net  
[Http://www.tci-counter.com](http://www.tci-counter.com)

**Product:Measuring Wheel**



WE TOOLS CO., LTD.  
 No.1408,Sec.2,Bixing Rd.,Caotun  
 Township,Nantou County 542, Taiwan  
 Tel:+886-49-2330717  
 Fax:+886-49-2330197  
 E-mail:we.tools@msa.hinet.net  
[Http://www.we-tools.com.tw](http://www.we-tools.com.tw)

**Product:Hand riveter**



TUNG JINN ABRASIVE CO., LTD.  
 No.81, Guogou, Beigang Township,  
 Yunlin County 65150, Taiwan  
 Tel:+886-5-7833371  
 Fax:+886-5-7822877  
 E-mail:trade@tja.com.tw  
[Http://www.tungjinn.com.tw](http://www.tungjinn.com.tw)

**Product:Non-slip Mat**

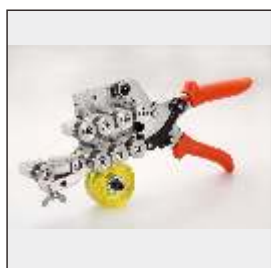

HONG JIN HARDWARE CORPORATION  
 No.14, Ln. 461, Pengyi Rd., Taiping Dist.,  
 Taichung City 411, Taiwan  
 Tel:886-4-2276-7140  
 Fax:886-4-2275-8163  
 E-mail:hongjin461@gmail.com  
[Http://www.mitre-cutters.com](http://www.mitre-cutters.com)

**Product:Tube Straightener**



FERRO-CARBON ENT. CO., LTD.  
 No.20, Jing 1st. Rd., Sec. 1, Taichung Part Technology Industrial Park,  
 Wuqi Dist.,Taichung City 43541,Taiwan  
 Tel:+886-4-26595889  
 Fax:+886-4-26595881  
 E-mail:service@ferro-carbon  
[Http://www.ferro-carbon.com](http://www.ferro-carbon.com) [www.feca.com.tw](http://www.feca.com.tw)

**Product:Suction Cup**



**B.H.SHOW CO.,LTD.**  
 No.5,Lane 133,Sec.1,Shihpai Rd.,  
 Changhua,50034 Taiwan  
 Tel:886-4-7380415  
 Fax:886-4-7380414  
 E-mail:bhshow@ms21.hinet.net  
[Http://www.bhshow.com.tw](http://www.bhshow.com.tw)

**Product:**Garden Hose



**Gwo Forng Enterprise Co., Ltd.**  
 No.438, Sec.3, Chang Yuan Rd., Hwatan Hsiang,  
 Changhua Hsien 503, Taiwan  
 Tel:+886-4-7124486 Fax:+886-4-7127166  
 E-mail:gwoforng@gmail.com  
[Http://www.gf-hardware.com](http://www.gf-hardware.com)

**Product:**Building&Bathroom Hardware



**LEI MING INDUSTRIAL CO., LTD.**  
 No. 13-12 Chunggho Lane, Fengtien Li, Erhlin Town,  
 Changhua Hsien, Taiwan 52655  
 Tel:+886-4-8961951  
 Fax:+886-4-8966416  
 E-mail:Lm961951@ms58.hinet.net  
[Http://www.lmcaster.com](http://www.lmcaster.com)

**Product:**Casters,Racks



**PRODUCTION EQUIPMENT  
&OEM/ODM  
RUBBER**

**PRODUCTION EQUIPMENT &OEM/ODM**





# 益祥金屬工業有限公司 ELE SHINE METAL INDUSTRIAL CO., LTD.

No. 60, Ln. 376, Sec. 7, Erxi Rd., Erlin Township, Changhua County 526, Taiwan  
 TEL: +886-4-8685008 FAX: +886-4-8685489  
 E-mail: ele.shine@msa.hinet.net Http://www.ele-shine.com.tw



## Professional Metal Parts Manufacturer





益祥金屬



ISO 9001:2015  
Welcome ODM/OEM



# 元久金屬

## 專業沖床加工



**Stamping for:  
Iron, Copper, Aluminum, Stainless Steel, Plastic**



**元久金屬有限公司**  
**YUAN JIU METAL CO., LTD.**  
彰化縣和美鎮厚北路61巷61號

No. 61, Ln. 61, Houbei Rd., Hemei Township,  
Changhua County 508, Taiwan  
TEL:+886-4-7553294 FAX:+886-4-7553406  
E-mail:yuanjiu168@gmail.com <http://www.yuan-jiu.com.tw>  
E-mail:yuanchiu168@gmail.com <http://www.yuanchiu.com.tw>



# 各種五金零件專業製造

## Various Parts for Hardware



**CNC**  
自動走心走刀車銑複合加工  
同茂企業有限公司

地址：彰化縣和美鎮克東路108號

Tel:+886-4-7359771 | Fax:+886-4-7359850

No.108, Kedong Rd., Hemei Township,  
Changhua County 508, Taiwan

E-mail:loop00123a@gmail.com

Http://www.tongmao-cnc.com.tw







*Our main products:*

Die-casting, Forged, Locks,

CNC-Machined and Plastic Parts

OEM and ODM orders are welcome

All-around services



Aluminum Die Casting



Zinc Die Casting



Counters



CNC Machined Parts



Gravity Casting



Lock Sets

**GREY Co.**

[www.grey.com.tw](http://www.grey.com.tw) [service@grey.com.tw](mailto:service@grey.com.tw)





# Chien Chie Rubber Technology Co., Ltd.



[www.chien-chie.com](http://www.chien-chie.com)



**Boots.  
O-rings.  
Packing.  
Bushings.**

**Rubber seal.  
Vacuum cups.  
Rubber Gaskets.  
Custom rubber seals**



**Address: No.27, Ln. 85, Sec. 1, Jiatou Rd.,  
Longjing Dist., Taichung City 434, Taiwan  
Tel: 886-4-26366059 Fax: 886-4-26366038  
E-mail: tccr@chien-chie.com.tw  
<http://www.chien-chie.com>**



# SAN MAW RUBBER INDUSTRIAL CO.,LTD

No. 10, Dongshi Ln., Ting Nien Village, Fuxing Township, Changhua County 506, Taiwan  
TEL:+886-4-7708736 FAX:+886-4-7706214 E-mail:v823@ms25.hinet.net  
Http://www.3maw.com.tw www.3maw-rubber.com



**3maw**

# O-RING X-RING VA, VL, VS SEAL WASHER RUBBER, GASKET RUBBER PACKING RUBBER CAP





# Transmission Belt

 **ELEPHANT**  **MOUNTAIN**

**TAHSIANG INDUSTRY CO., LTD.**

No. 82, Doutan Rd., Shalu Dist, Taichung City, 433 Taiwan

Tel: +886-4-26352277-8 Fax: +886-4-26352279

E-mail: [tahs3566@tahs-belts.com](mailto:tahs3566@tahs-belts.com)

Http://www.tahs-belt.com







## JIA HUNG ENTERPRISE CO., LTD

No. 77, Chipan Lane, Gochien Li, Lukang Town,  
Changhua County, 505 Taiwan

Tel:886-4-777-9606 | Fax:886-4-777-0406

E-mail:jiahung@jiahung.com

www.jiahung.com



# PLASTIC INJECTION



OFFICE APPLIANCES  
HOUSEWARE  
OEM/ODM







No. 77, Chipan Lane, Gochien Li, Lukang Town,  
Changhua County, 505 Taiwan  
Tel:886-4-777-9606 | Fax:886-4-777-0406  
E-mail: [jiahung@jiahung.com](mailto:jiahung@jiahung.com)  
[www.jiahung.com](http://www.jiahung.com)





# SUPPLIERS DIRECTORY

PRODUCTION EQUIPMENT  
OEM/ODM  
RUBBER



**WEI HONG PRECISION MACHINERY CO., LTD.**  
 No.1065, Fengzhou Rd., Shengang Dist.,  
 Taichung City, 42950 Taiwan  
 Tel: +886-4-25610595  
 Fax: +886-4-25632426  
 E-mail: wehong@ms75.hinet.net  
[Http://www.gundrilling.com.tw](http://www.gundrilling.com.tw)

**Product: Gun Drilling Machine**



**XIN WARE ENTERPRISE CO.**  
 No. 17, Sec. 1, Hexiang Rd., Beitun Dist.,  
 Taichung City 406056, Taiwan  
 TEL: +886-4-24960089 FAX: +886-4-24960180  
 E-mail: xinhardware80@gmail.com  
[Http://www.xin-hardware.com](http://www.xin-hardware.com)

**Product: CNC Processing**



**ELE SHINE METAL INDUSTRIAL CO., LTD**  
 No. 60, Ln. 376, Sec. 7, Erxi Rd., Erlin Township,  
 Changhua County 526, Taiwan  
 TEL: +886-4-8685008  
 FAX: +886-4-8685489  
 E-mail: ele.shine@msa.hinet.net  
[Http://www.ele-shine.com.tw](http://www.ele-shine.com.tw)

**Product: Computer CNC Automatic Lathe  
 Milling Precision**



**TONG MAO ENTERPRISE CO., LTD.**  
 No.108, Kedong Rd., Hemei Township, Changhua County 508, Taiwan  
 Tel: +886-4-7359771  
 Fax: +886-4-7359850  
 E-mail: loop00123a@gmail.com  
<http://www.tongmao-cnc.com.tw>

**Product: CNC Processing**



**Yong Cheng Feng Technology Co., Ltd.**  
 No. 1-29, Yixing St., Xiushui Township,  
 Changhua County 504, Taiwan  
 TEL: +886-4-7618798  
 FAX: +886-4-7618797  
 E-mail: cf12@tgem.com.tw  
[Http://www.tgem-cnc.com.tw](http://www.tgem-cnc.com.tw)

**Product: Computer CNC Automatic Lathe  
 Milling Precision**



**YUAN JIU METAL CO., LTD.**  
 No. 61, Ln. 61, Houbei Rd., Hemei Township,  
 Changhua County 508, Taiwan  
 TEL: +886-4-7553294  
 FAX: +886-4-7553406  
 E-mail: yuanchiu168@gmail.com  
[Http://www.yuanchiu.com.tw](http://www.yuanchiu.com.tw)

**Product: Stamping**



TAHSIANG INDUSTRY CO., LTD.  
No. 82, Doooutran Rd., Shalu Dist.,  
Taichung City, Taiwan 433  
Tel:+886-4-2635-2277  
Fax:+886-4-2635-2279  
E-mail:tash3566@ms33.hinet.net  
[Http://www.tahs-belt.com](http://www.tahs-belt.com)

**Product:Transmission belt**



CHIEN CHIE RUBBER TECHNOLOGY CO., LTD.  
No.27, Ln. 85, Sec. 1, Jiatou Rd., Longjing Dist.,  
Taichung City 43443, Taiwan  
Tel:+886-4-2636-6059  
Fax:+886-4-2636-6038  
E-mail:service@chien-chie.com.tw  
[Http://www.chien-chie.com](http://www.chien-chie.com)

**Product:Rubber. Gasket**



SAN MAW RUBBER INDUSTRIAL CO., LTD.  
No. 10, Dongshi Lane, Dingnian Village,  
Fuhxing Township, Changhua County, Taiwan 506  
Tel:+886-4-770-8736  
Fax:+886-4-770-6214  
E-mail:v823@ms25.hinet.net  
[Http://www.3maw-rubber.com](http://www.3maw-rubber.com)

**Product:Rubber Parts**



ORIENTAL STAR CHEMICAL INC.  
No.171, Sec. 5, Zhonghe St., Xinshe Dist.,  
Taichung City 426, Taiwan  
TEL:+886-4-2582-1951  
FAX:+886-4-2582-5635  
E-mail:osc@oriental-star.com.tw  
[Http://www.oriental-star.com.tw](http://www.oriental-star.com.tw)

**Product:Rubber Bushing**



DOU YOAN LEI CO., LTD.  
No. 36, 40th Rd., Ind. Taichung City, Taiwan  
Tel:886-4-2359-9200  
Fax:886-4-2359-9208  
E-mail:dou.yoanlei@msa.hinet.net  
<http://www.ed-color.com.tw>

**Product:Color Electroplating**

# Telescopic Cylinder

Specialized  
Customization



web



facebook



**溢鑫工業有限公司**  
YI HSIN INDUSTRIAL CO., LTD.

513 彰化縣埔心鄉羅厝路三段220號  
No. 220, Luocuo Rd., Sec. 3, Puxin Township, Changhua, Taiwan 513  
Tel: 886-4-828-3386, 828-3306 Fax: 886-4-828-3351  
E-Mail: info@tipping-cylinder.com <http://www.tipping-cylinder.com>



Asia's Leading Premium Hardware Show

# TAIWAN HARDWARE SHOW 2024

Concurrent Expo:



**International Metal  
Technology Taiwan**



**T-SAFE**  
OCCUPATIONAL SAFETY TAIWAN



**Refrigeration  
& HVAC TAIWAN**

# 10.23-10.25

TAIPEI NANGANG EXHIBITION CENTER, HALL 2

## Exhibits Profile

-  Power Tools
-  Tools & Accessories
-  Locks & Fittings
-  Building Supplies
-  Fasteners & Fittings
-  Plumbing Hardware
-  Safety Equipment & Products
-  Machine & Plant Equipment
-  Automotive Supplies & Accessories
-  Garden & Outdoor Equipment

Organizer

**kaigo**  
Exhibition & Convention Expert

**Taiwan  
Industry  
Week**



SCAN ME

**Enquiry**

Tel: +886-2-2595-4212

E-mail: ths@kaigo.com.tw



# International Metal Technology Taiwan 2024 OCT.23-25

Taipei Nangang Exhibition Center, Hall 2

◆ The entire metal supply chain under one roof !



Forging



Foundry



Metallurgy



Heat  
Treatment



Metal  
Materials



Metal Forming  
Technology



Wire



Tube



Industrial  
Machinery



Welding



Test  
Equipment



Mold

**Exhibiting Area (sqm)**

**10,000<sup>+</sup>**

**Visitors**

**25,000<sup>+</sup>**

**Visiting Countries**

**80<sup>+</sup>**

**Exhibitors**

**300<sup>+</sup>**



**An exclusive subsidy covering accommodation and airport pick-up worth **TWD15,000** will be given to qualified buyers\***

*\*based on selection eligibility*

**Penetrate Global Market Trends  
Start A New Business Model.**

**The best chance to  
link up with the world.**

**Taiwan is prosperous  
in metal industry**

iMT will attract exhibitors and visitors from the entire metal industry's supply chain looking for material, products, machinery and seeing for new business. In addition, Taiwan's diverse metal factory clusters, factory tours are convenience for all international exhibitors and visitors.

Organizer

Exhibition & Convention Expert  
**kaigo**

Website



# YHCASTER

Bearings, Industrial Casters and Hand Trucks Manufacturer



ISO 9001:2008  
ISO 14001:2004  
Management System  
www.yh.com  
ID: 0109823595



17-001



17-002



17-003



17-004



17-064



17-065



17-005



17-006



17-007



17-008



17-009



17-010



Trolley -25



17-011



17-012



17-013



17-014



17-015



17-016



17-017



17-018



17-019



17-020



17-021



17-022



17-023



17-024



17-025



17-026



17-027



17-028



17-029



17-030



17-031



17-032



17-033



17-034



17-035



17-036



17-037



17-038



17-039



17-040



17-041



17-042



17-043



17-044



17-045



17-046



17-047



17-048



17-049



17-050



17-051



17-052



17-053



17-054



17-055



17-056



17-057



17-058



17-059



17-060



17-061



17-062



17-063

## Y.H CASTER CO., LTD.

No. 42, Ln. 251, KOUZHUANG St., Huatan Township, Changhua County 50353, Taiwan  
TEL: 886-4-763 7070 FAX: 886-4-763 7080  
E-mail : yhcaster@hotmail.com / service@yhcaster.com  
http://www.yhcaster.com  
http://www.fastener-world.com.tw/yhcaster





# SAFETY BELT/ HARDWARE

安全帶 / 掛件五金

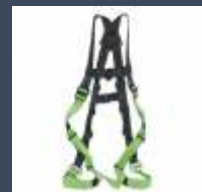
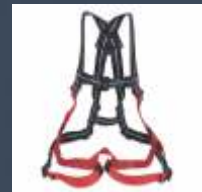

**YI FONG IND. SAFETY PRODUCTS CO., LTD**  
 No. 105, Ln. 416, Sec. 2, Yaofeng Rd., Puxin Township,  
 Changhua County, Taiwan  
 Tel: 886-4-8285900 Fax: 886-4-8285903  
 E-mail: kaiyo7@yahoo.com.tw ; kaiyokae@gmail.com  
 Http://www.kai-yo.com/



# Garden Hose

## Professional Manufacturing



***B.H.SHOW CO.,LTD.***

No.5,Lane 133,Sec.1,Shihpai Rd.,Changhua,50034 Taiwan

TEL:886-4-7380415 FAX:886-4-7380414

E-mail:bhshow@ms21.hinet.net

Http://www.bhshow.com.tw



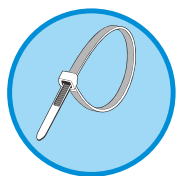

# CABLE TIE

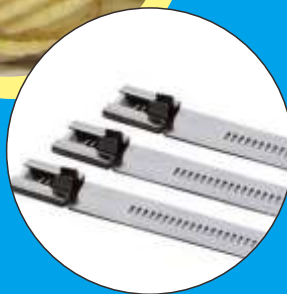
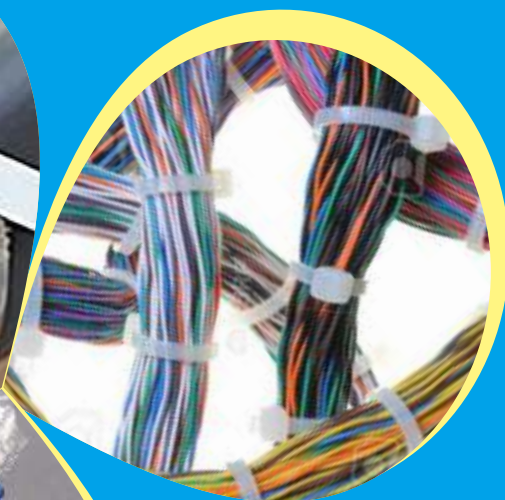

Plastic Cable Tie

Silicone Cable Tie

Stainilss Cable Tie

Handtools

## HMIT TRADING CO.

13F-5, No.100, Sec. 1, Zhongqing Rd., North Dist.,  
Taichung City 404, Taiwan

TEL:886-4-8535499 FAX:886-4-22083823

E-mail:hmitivy@gmail.com

[Http://www.cable-tie.com.tw](http://www.cable-tie.com.tw)

# Professional America Hose Clamps



**YNX CHING ENTERPRISE CO., LTD.**

No. 1, Shangshan Rd., Daya Dist., Taichung City, 42878 Taiwan

Tel: 886-4-25674668 Fax: 886-4-25671708

E-mail: [ynx.ching@msa.hinet.net](mailto:ynx.ching@msa.hinet.net) <http://www.ynxching.com>